

DATE MAY 11, 2015	OUTLINE DIMENSIONS 3-PHASE INDUCTION MOTOR	MOTOR TYPE: AEUHXG
CATALOG NO. XPV0154C		FRAME NO. 254TC

Pole	HP	KW	Hz	VOLT	Syn. Speed RPM
4	15	11.2	60	230/460	1800

Ins	Rating	Dimension in	Approx Weight	Bearings	
F	CONT.	inches	360 lbs.	DE: 6309ZZ	NDE: 6307ZZ

Totally Enclosed Fan-Cooled Type. Squirrel-Cage Rotor.

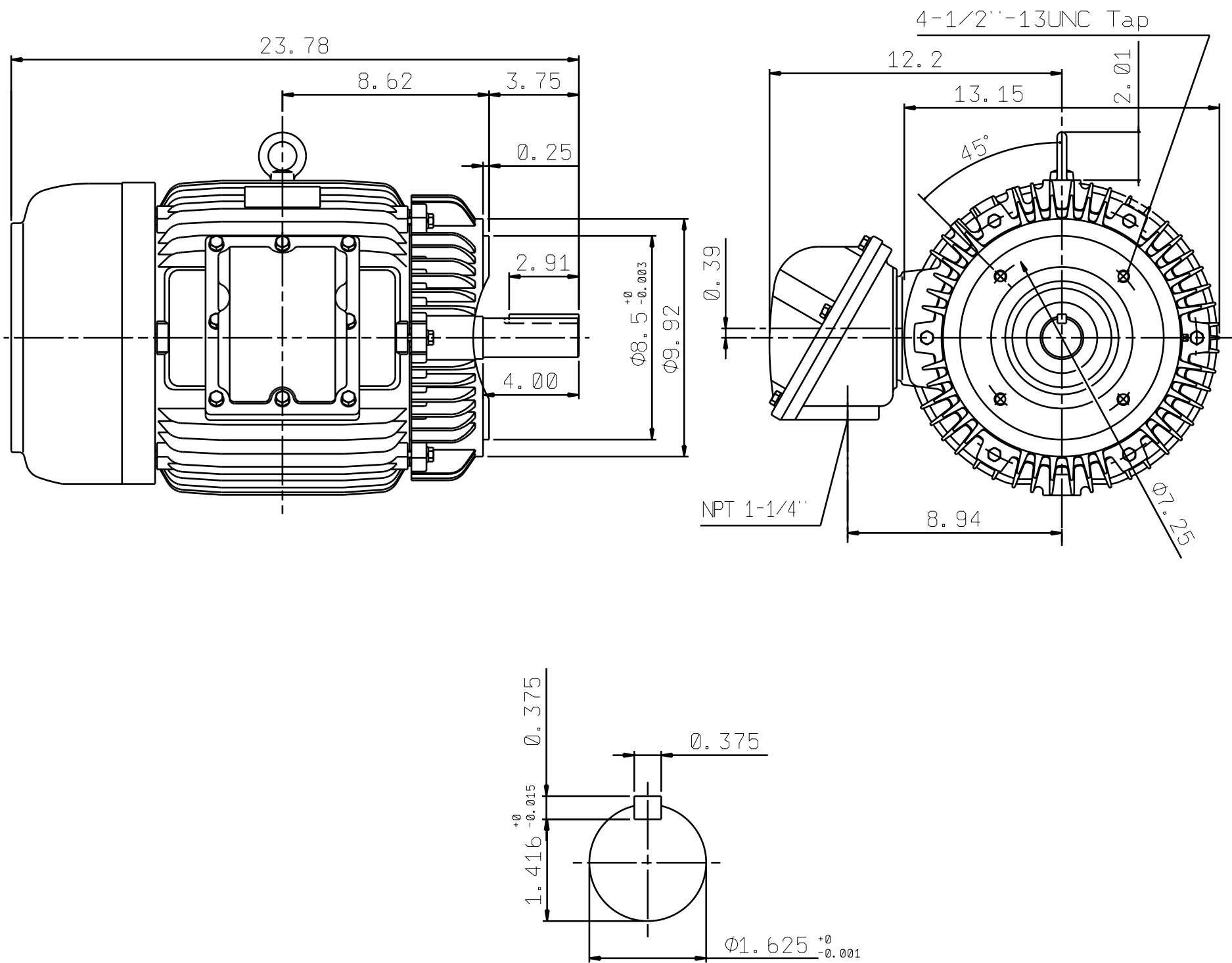

NOTE:

- EXPLOSION PROOF:
CLASS I, DIV 1, GROUP C+D, ^J
CLASS II, DIV 1 and 2, GROUP
E, F, G.

--	--	--

DWN.	J.H. LIANG	12-04-98		DWG NO.
CHKD.	C.S. LO	12-10-98		
APPD.	Y.B. HUANG	12-10-98		